

Design and Deployment of the Bonne Bay Observatory (B₂O)

B. de Young

Department of Physics and Physical Oceanography, Memorial University of Newfoundland, Prince Philip Dr., St. John's, NF A1B 3X7 Canada

K.M. Brown, R.S. Adams

Satlantic Inc, 3481 North Marginal Rd., Halifax, NS B3K 5X8 Canada

S.D. McLean

WETSAT Inc., 3481 North Marginal Rd., Halifax, NS B3K 5X8 Canada

Abstract - We have deployed the Bonne Bay Observatory (B₂O) in Bonne Bay, a fjord on the west coast of Newfoundland, in the spring of 2004. The scientific goal of this system is to provide continuous, year-round, real-time data to enhance our understanding of the coupling between the physical and biological environment in this sub-Arctic fjord, which is ice covered for several months each year. The Observatory permits investigators to schedule and interactively manage real time data acquisition and control of the network of sensors. Serving a multidisciplinary team, the instrument array is diverse, including acoustic sensors to determine currents, bubble distribution and plankton abundance, video to determine plankton and benthos species abundance, and sensors for temperature, salinity, chlorophyll fluorescence, carbon dioxide, oxygen, inorganic nutrient concentrations and spectral irradiance. Instruments are deployed on fixed and moveable structures and on an underwater profiling winch. The control and telemetry system includes a power distribution sub-system and TCP/IP based network consisting of two local area networks, one on shore linking data acquisition and control computers and one underwater connecting the sensors, joined by an armored 1.4 km electro-optic cable. The cable provides up to two 100BASE-FX network connections and 2 kW of power to the underwater systems. The system is designed to operate autonomously, and to be controlled remotely by the DACNet ocean observatory operating system. The underwater hardware elements are modular, accommodating guest instruments at spare Ethernet and serial ports. The paper describes the system design with description of instrumentation deployed underwater for the first time, lessons learned during design and deployment and presents preliminary samples of the data collected.

I. INTRODUCTION

The observatory was deployed in Bonne Bay to understand the influence of the physical environment on the temporal variability of marine ecosystems. The observatory is located on the sill of this dynamic fjord, which is located in the northeastern Gulf of St. Lawrence. Located in shallow water, for ease of access, the sensor suite sits on the sill between the water of the inner basin of the fjord and the Gulf of St. Lawrence. The strong tidal

cycle ensures that the system detects the cyclic water and biological properties of Bonne Bay.

The deployed instrumentation measures water properties and includes innovative video and acoustic technologies that permit studies of organisms previously poorly observed and scientifically neglected. The state-of-the-art, in situ instrument array includes direct water property measurements, acoustic sensors for determination of currents, bubble distribution and plankton abundance, video technologies for determination of plankton and benthos species abundance, dissolved gas, nutrient and light sensors. Data is transmitted through the electro-optic cable to the Marine Station and is available to researchers in real-time. The Observatory has a modular design so that individual serviceable components may easily be exchanged or serviced. The shallow location (approximately 25 m) permits servicing by divers. The Bonne Bay Marine Station (Fig. 1)(see www.bonnebay.ca), which also houses a meteorological station, provides a secure site for the power supply, computer control and data acquisition for the subsea node. Shore based computers collect the data from the observatory and make it available for scientific and educational use. A small research vessel complements the fixed sensor array of the Observatory.

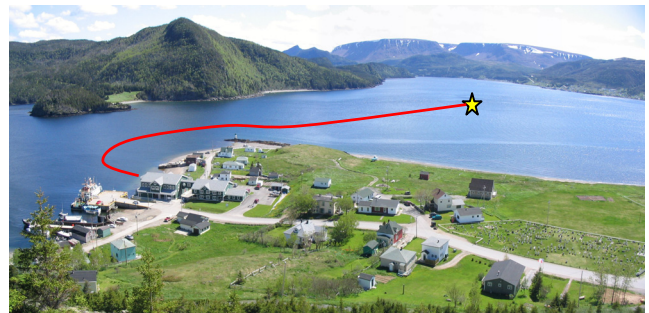

Fig.1. Bonne Bay Observatory Marine Station (the line shows the approximate location of the cable running from the marine station at the shore out to the sill where the observatory is located)

II. SYSTEM DESIGN

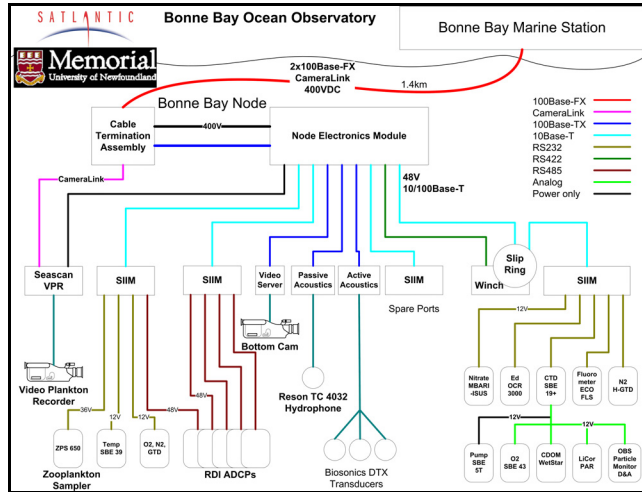

Fig.2. Bonne Bay Block Diagram

The Bonne Bay Observatory architecture represents a hierarchical layering of infrastructure to support continuous observation of the marine ecosystem. The design is based upon the DACNet (Data Acquisition and Control Network) ocean observatory operating system [2] developed for the Dalhousie University MEPS buoy network [1], the CNRS BOUSSOLE buoy system [4], and is currently being deployed on the Rutgers University LEO-15 cabled observatory [3]. The hardware design originally considered a similar architecture as the buoy system [1,4], with a central control computer and local computers controlling acquisition at each experiment site. With the significant increase in bandwidth and power available with an electro-optic cabled system, such a design was no longer necessary. Furthermore, to place primary acquisition computers on the sea bottom where access would require diver operations, was undesirable from both a reliability and maintenance perspective. The system design approach used a distributed network of robust SCADA (Supervisory Control and Data Acquisition) Remote Terminal Units (RTUs) widely used in industrial control systems using MODBUS/TCP for the control elements and interface adapters to convert sensor protocols to Internet Protocols (IP) for the science instrument ports.

The system consists of a shore based control computer and power supply connected to an electro-optic cable that runs 1.4 km to a cable termination assembly. The cable termination assembly provides the mechanical, fiber optic and electrical termination for the main cable, communication media conversion from optical to copper Fast Ethernet, and an interface for fiber optic instruments. From the cable termination assembly, the main power and communications for the observatory connect to the node electronics module which steps the power feed voltage from 400 VDC down to the observatory operating voltage of 48 VDC and provides eight 10/100BASE-TX Ethernet

ports to the sea floor observatory. Each of these ports is connected to a SIIM (Science Instrument Interface Module) or directly to Ethernet based instrumentation. The SIIMs provide control, isolated and regulated power to each of the serial protocol instruments and act as interface adapters to convert serial protocols to IP protocols used by the observatory. See Figure 2 for a system block diagram.

III. SYSTEM CONFIGURATION

The system is configured with two main sensor concentrations: at the central node, and at a 5 m tower located 20 m from the central node. An array of ADCPs spread across the sill is also planned, but not yet deployed.

The central node is the location for the main cable termination, node electronics module, the primary acoustic systems, and an underwater profiling winch (Fig. 3). A SIIM located at the central node will connect to the planned array of ADCPs, which are distributed along an 800 m line across the channel. A second SIIM is located on the profiler package to interface with the profiling instrument package.

The connections at the node (except for the fiber optic connections) are all diver mateable and each infrastructure module is housed in a stainless steel enclosure configured for diver serviceability and easy deployment of experiments.

The Bonne Bay Observatory has an impressive instrument array to address temporal and spatial variability issues, and provide visualization of the ecosystem.

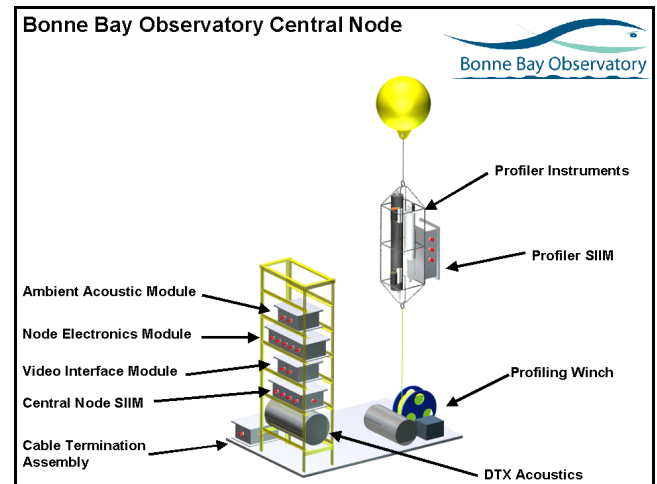

Fig.3. Bonne Bay central node configuration

To visualize the vertical structure of the water column a bottom mounted underwater winch is used. This allows continuous profiling of the water column even during the winter when the observatory is under the ice. The profiler contains two CTDs, DO, CDOM fluorometer, OBS, chlorophyll fluorometer, gas tension, hyperspectral radiometer and nitrate sensors. All of these sensors connect to a SIIM on the profiler, which transmits the data

back to the shore station via Ethernet. Two CTDs provide for redundancy of these critical measurements, which are important not only for interpreting the other data collected, but also for managing the winch activity.

A video camera with LED illumination provides continuous monitoring of the winch system and provides visualization of the sea bottom at the central node. The video is MPEG-2 compressed by a video server located at the central node. Two 100W halogen lamps are provided for aiding divers, with the intention of permitting night dives at the site.

A three frequency Biosonics DTX (120, 220, 440 kHz) provides acoustic profiles of zooplankton and fish populations (Fig. 4), while an ambient acoustic module provides broadband (up to 100 kHz) acoustic data. Both of these high bandwidth systems use a 100 Mbits/s Ethernet interface.

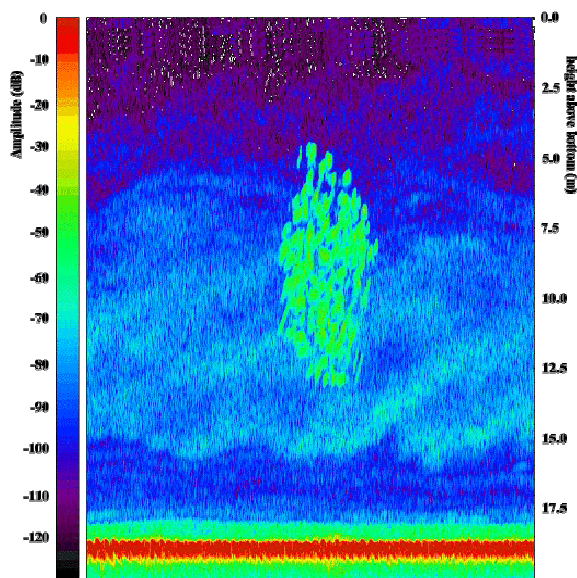

Fig. 4. Upward looking acoustic backscatter from the Bonne Bay BioSonics DTX system. (The red line, indicating high intensity backscatter, is from the sea surface. The ripples in this short ten minute record are from surface waves. The medium intensity backscatter in the middles is from a school of small fish – sand lance)

Five ADCPs can be spaced across the channel where the observatory is deployed. These are serial interface sensors. Four of these will connect to the central node SIIM, currently one is connected to the tower SIIM.

Deployed at the tower site are a McLane Zooplankton Sampler, a Sea-Bird precision temperature sensor, ProOceanus O_2 and N_2 gas sensors, and a Seascan Video Plankton Recorder (VPR). The sampler, temperature and gas sensors are serial devices and interface to the observatory via the tower SIIM. The VPR utilizes a CameraLink fiber optic interface. Because no IP based protocols were available for this product, a dedicated fiber pair was used to send the data back to the VPR computer in the shore station at sustained data rates of 600 Mbits/s. Devices like the VPR demonstrate the unique capability of

cabled observatory systems to visualize marine ecosystems in real time (Fig. 5).

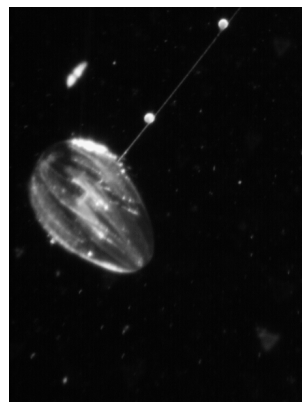

Fig. 5. Zooplankton image from the Bonne Bay Seascan VPR

Spare ports for guest instruments are available on the node electronics module for Ethernet based systems or additional expansion SIIMs and a spare SIIM is also available for serial protocol instruments.

IV. POWER SYSTEM

The power system for Bonne Bay is designed to deliver sufficient power to the experiments, provide a high level of system control for operators, provide isolation so that instruments causing ground or power faults do not affect any others, provide protection for the infrastructure, and to provide protection for divers servicing the system (Fig. 6). The power system delivers 2 kW to the observatory node over a voltage range 300-425 VDC. The isolated power is delivered to the node from a 600 VDC, 5.4 kW shore side power supply via an armored electro-optical cable with six 14 AWG conductors. The main cable is ground fault protected and trips off the shore station power supply when the ground fault reaches 6 mA. The main power supply and shore server computer operate from two dedicated Uninterruptible Power Supplies (UPS) that can provide roughly 30 minutes of backup. The backup power supply is designed to enable the observatory to ride through short (seconds to minutes) power losses and to permit sufficient time for a graceful shutdown if necessary.

At the node, DCDC converters drop the backbone voltage of 400 VDC to the isolated node bus voltage of 48 VDC. This supply, located in the node electronics module, can supply up to 1.8 kW to the science experiments. An additional 100 W power supply in the cable termination assembly provides 5 V for redundant media converters for the main communications link to shore. Each of the eight science ports of the node electronics module has an isolated 250 W supply, except for the winch port, which is 500 W. Each of these ports is ground fault protected and automatically trips off when the ground fault exceeds 16

μ A. Power for each port is controlled through the DACNet system on shore using Ethernet controllable relays.

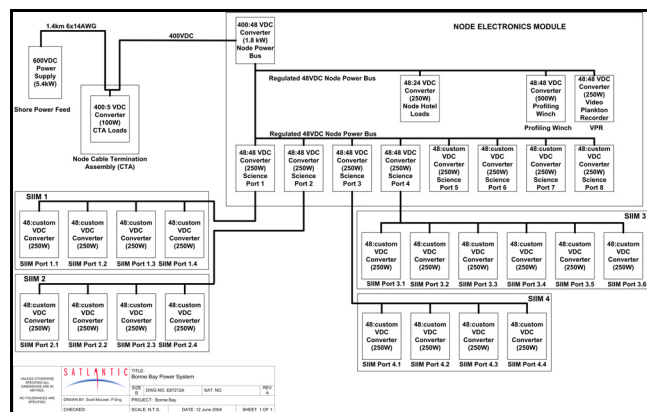

Fig. 6. Bonne Bay Power System Block Diagram

Each SIIM in Bonne Bay is configured with a 48 VDC input and can supply up to 250 W to each of the four or six serial instruments. Each instrument port power supply is isolated to keep problems experienced at one port from affecting the others on the same SIIM. To make it as easy as possible for guest instruments to be connected to the observatory, a wide range of voltages is available for each port. Voltages 5, 6, 12, 15, 24, 28, 36, or 48 are switch selectable in the SIIM prior to deployment. Each port is ground fault protected and automatically trips off when the ground fault exceeds 16 μ A.

V. COMMUNICATIONS SYSTEM

The communications system is designed to make it easy for observatory users to connect instruments and access the data on shore (Fig. 7). The system is implemented as a local area network using Internet Protocols (IP) over Fast Ethernet (100BASE-TX). User computers can connect to the observatory infrastructure through a network switch at the shore station. The shore station switch is connected to the primary switch in the node electronics module by a fiber optic bridge. The fiber optic bridge consists of two redundant 100BASE-FX channels. Each uses bi-directional wave division multiplexing media converters at each end to connect from copper media to optical and achieve full duplex communication on a single fiber. The switch is connected to a media converter that translates the 100BASE-TX used in the shore station to 100BASE-FX that is transmitted over the fiber optic cable to the observatory node. In the cable termination assembly, a media converter changes the 100BASE-FX back into 100BASE-TX, which connects to a primary network switch in the node electronics module. The switch in the node electronics module connects to each of the science ports providing eight 10/100BASE-TX interfaces for SIIMs or Ethernet based instrumentation. Several additional Ethernet ports are used for local control

within the node electronics module and also for a serial terminal server for the winch controller port.

Each SIIM uses either four or six serial terminal servers to convert serial instrument protocols to Ethernet. The protocols in the serial terminal servers are software selectable to RS232/422/485 with input baud rates of 300 – 230400 bits/s. The control and monitoring system within the SIIM also uses an Ethernet port. The control and monitoring system and the serial servers are multiplexed together on a single 10BASE-T interface to the node electronics. The SIIMs make the observatory very modular, greatly minimizing system wiring and optimizing the use of node electronic module ports.

The video camera connects to the node through a video interface adapter that was created as a separate module to convert RS-170A analog video (Color NTSC or PAL) to streaming digital video over Ethernet. The video ports have both composite video and S-Video connections. Each video port uses a video server to MPEG-2 compress the incoming video. Web services for this device, including video options and pan/tilt/zoom controls (if the camera is so equipped) are accessed from the shore LAN. The compression is selectable for bandwidths of 0.5 to 8 Mbits/s.

For the first year of operation the observatory did not have a high bandwidth backhaul for real time access to data outside of the marine station. DACNet command and control interfaces were available through a modem connection to the shore server. In June of 2005 a dedicated fiber was connected to the marine station, allowing for real time command and control, and high-speed data access.

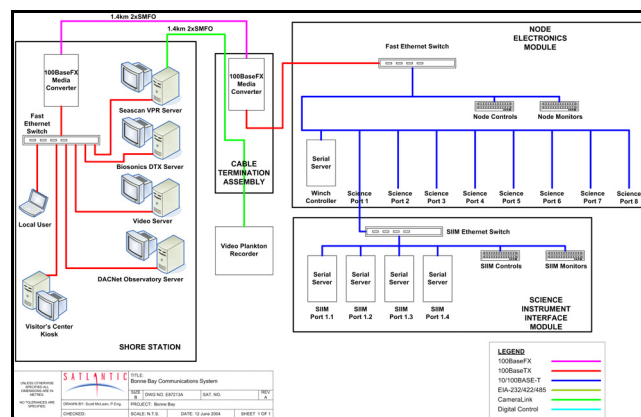

Fig. 7. Bonne Bay Communications System Block Diagram

VI. CONTROL SYSTEM

The Bonne Bay Observatory controlled by the DACNet R3 ocean observatory operating system running on the shore station host server. DACNet provides remote interfaces for both manual and fully automated control of the observatory instruments and infrastructure. These interfaces are essential during the winter months when the unmanned station is monitored and controlled remotely from Memorial University located 450 km away.

DACNet's primary roles are observatory command and control (including the profiling winch) and to acquire data from the observatory instruments. Observatory infrastructure configuration and acquisition scheduling is implemented using XML metadata, which makes the system dynamically configurable and provides a mechanism to implement adaptive sampling.

DACNet communicates with the hardware control elements of the observatory through the MODBUS application layer protocol implemented over TCP/IP. The primary hardware control elements are SCADA relay control modules placed within the infrastructure elements. A web browser user interface allows for easy configuration of the infrastructure remotely or from the shore station.

DACNet provides a web browser interface for scheduling data acquisition from instruments in the infrastructure. This includes the ability to script pre and post acquisition commands to the instruments for clock synchronization, internal configuration and to interactively change instrument sampling.

DACNet stores all acquired data in native instrument format, optionally with imbedded metadata (such as time tags) on the shore server. Users may access data from the server or they can acquire data directly from the instrument by connecting to the instrument's network socket. Once a high bandwidth backhaul connection is installed at the observatory, DACNet will be able to stream instrument telemetry in real time to users on the Internet.

DACNet continuously monitors system states and reports any detected changes or deviations to the system log file. Critical problems are immediately reported to the system operators and users via email and/or pager. This includes fault detection (port shut downs) and loss of instrument telemetry.

A more detailed description of DACNet is provided in a companion paper [2].

VII. PORT SIMULATOR

An observatory port simulator (OPS) was developed for testing instruments in the lab before deployment (Fig. 8). It is very important to test instruments submerged in seawater with full ground fault checks before deploying on the full system. Immersing in fresh water and ground pressure cases using wires in insufficient to catch all of the potential fault paths that may be experienced in the ocean.

The OPS is a rack-mountable test set with a 500 W port and a 250 W port which duplicate the power, communications and control interfaces of the ocean observatory. Both ports are configurable for either Ethernet or serial communications, therefore all science port configurations are testable, including the winch port. It is possible to test configurations from the simple, one or two serial instruments, up to the complex, the profiling winch combined with a SHIM supporting up to six serial instruments. The port simulator measures the current requirements and the ground fault characteristics of the instruments under test. DACNet R3 can be run on a laptop

computer and provides the same functionality for the port simulator as for the observatory. The port simulator helps verify all aspects of instrument integration, including metadata and provides a platform for offline observatory operator training.



Fig. 8. Bonne Bay Observatory Port Simulator

VIII. DEPLOYMENT

The system was deployed in a fresh test tank at the National Research Council Institute for Ocean Technology on the St. John's campus of Memorial University in November-December 2003 for pre-deployment grooming that included testing, operator and diver familiarization, and deployment rehearsal. A representative set of instruments was deployed to exercise the system in all respects including winch operations. While not all of the problems experienced in the field were resolved in this tank test, it was a crucial step in the successful deployment of the observatory.

In early June 2004, the cable was laid from the Marine Station out to the node site on the sill at the entrance to the East Arm of Bonne Bay using the university's R/V Lauzier. The node mechanical structure was deployed with most infrastructure elements, some instruments, and the video camera. The system was powered up within one hour of deployment and operators were able to watch a live video feed of the divers completing deployment operations.

Following extensive experience with recovery and deployment of instrumentation and modules, the team discovered that divers and small boats were much more reliable and effective than large ships and cranes. The winch, for example, with which there were some problems on initial deployment, necessitating recovery and replacement of connectors and the profiling cable, weighs several hundred pounds in air. It was discovered that a single lift bag is sufficient to hold the winch at the surface. The winch can then be towed to the site suspended from the lift bag, at dead slow using a small boat. Divers then release air from the lift bag and are able to guide the winch

to its seating location on the main stainless steel node plate. The profiling package has been recovered and redeployed several times by winching the cable to the surface, attaching the cable to the package in a small boat and then winching the package down to the bottom. The video camera system has proved to be very valuable in monitoring this and other diver activity.

Once deployed in seawater, the system began to experience significant problems with ground faults despite all previous testing. Eventually all of the ground fault problems (except the profiling winch ground faults which were traced to internal wiring of the winch motor housing), were determined to be caused by the connectors used. Surprisingly, the original connectors used, specified as underwater mateable, turned out to be unsuitable for this continuous use application, resulting in significant maintenance due to poor contact and contact seal tolerancing. Custom locking sleeves were manufactured by Memorial and deployed to improve the performance of the connectors, and while these sleeves did make it possible to fully seat and easily remove the connectors, the ground fault problems persisted. These connectors are unsuitable for observing system applications and are all being replaced with wet mateable connectors from a different manufacturer during a summer maintenance period.

Despite these connector problems, the system has provided some excellent data sets, and the real time data from the high bandwidth visualization systems such as the video camera, the VPR, and the DTX are very impressive. Operations so far have helped develop maintenance and operational procedures and have provided validation of the overall design. The modular node infrastructure has proved to be diver friendly, allowing individual components to be recovered for maintenance and experiment deployments without disrupting the operations of the rest of the system.

REFERENCES

- [1] S.D. McLean, C.D. Dempsey, R.S. Adams, J.J. Cullen, and R. Davis, "The Marine Environmental Prediction System (MEPS) a new generation of moored ocean observing systems," *Proceedings of Oceans 2005*, in press.
- [2] R.S. Adams, P. Hoyt, G. Davidson, and S.D. McLean, The Data Acquisition and Control Network (DACNet) ocean observing operating system, *Proceedings of Oceans 2005*, in press.
- [3] E.L. Creed, S. Glenn, O.M. Schofield, H. Barrier, R.F. Petrecca, J.A. Dobarro, S.D. McLean, A.H. Barnard, K.M. Brown, R.S. Adams, and S. Feener, "LEO-15 Observatory – The next generation," *Proceedings of Oceans 2005*, in press.

- [4] D. Antoine, A. Morel, S.B. Hooker, B. Gentili, F. Louis, J. Ras, E. Roussier, D. Tailliez, J-F. Desté, P. Guevel, and C. Dempsey, "Medium Resolution Imaging Spectrometer (MERIS) validation: early results at the BOUSSOLE site (Mediterranean Sea)," *Envisat Validation Workshop Proceedings*, ESRIN, Frascati, Italy, 9-13 December, 2002.